

E+G GN 817 - NI positioneringsbolt

Greb, Maskin-, DIN- & Normdele > E+G Positionerings-elementer > E+G Positioneringsbolte > E+G Pos. bolte u/stopspærre > E+G GN



Vare:
Beskrivelse:

20265020
E+G
Positioneringsbolt GN
817-6-6-G-NI

<https://test.brd-kee.dk/produkter/20265020>

Mål

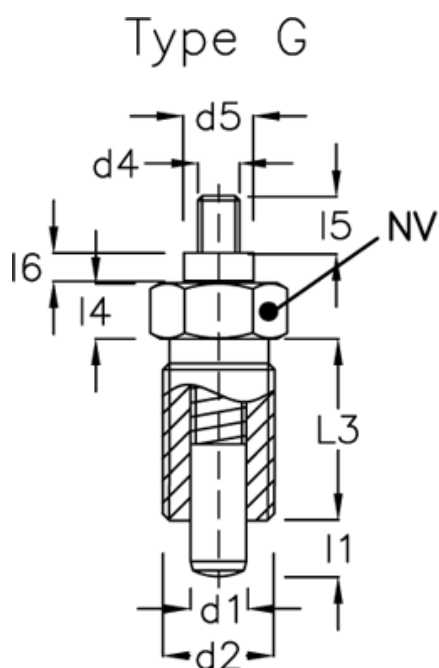

Type G
(åben)

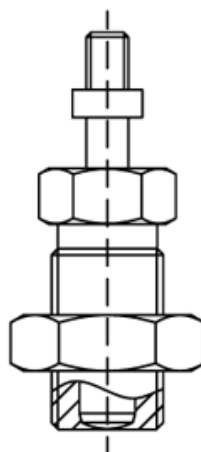

d1	=	6
d2	=	M12x1,5
d4	=	M5
d5	=	9
l1	=	6
l3	=	22
l4	=	6
l5	=	7.0
l6	=	3.5
NV	=	14

Fjedertryk N bund: 19.0

Fjedertryk N top: 6.0

Dokumenter, målskitser og brochurer af enhver slags kan indeholde fejl for hvilke Brd. Klee A/S ikke hæfter.